

**SECURITY SCREEN DOOR
MODEL 3800 - 18 GAUGE MAIN FRAME**

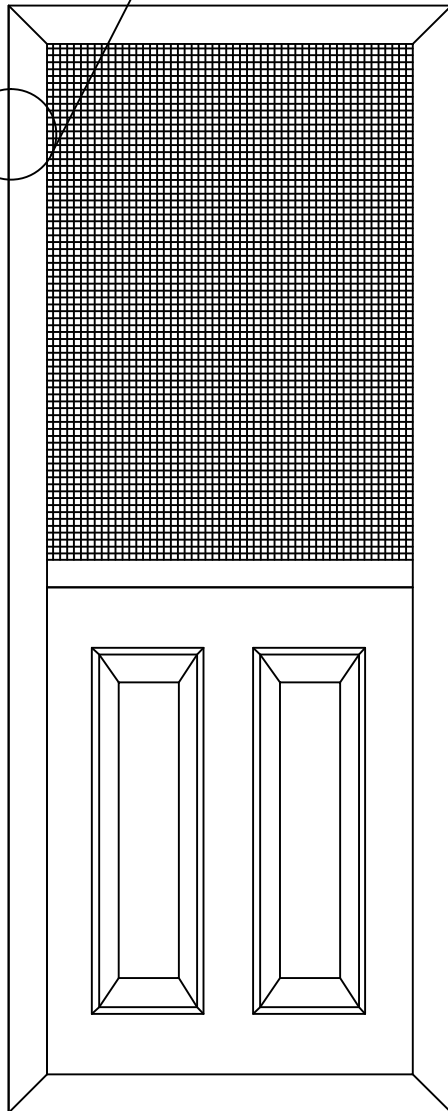

2010

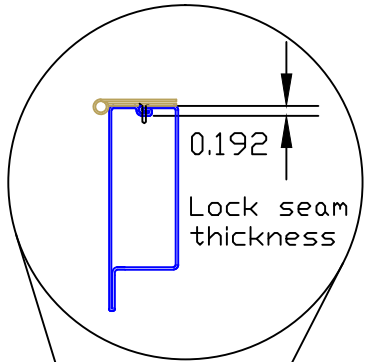
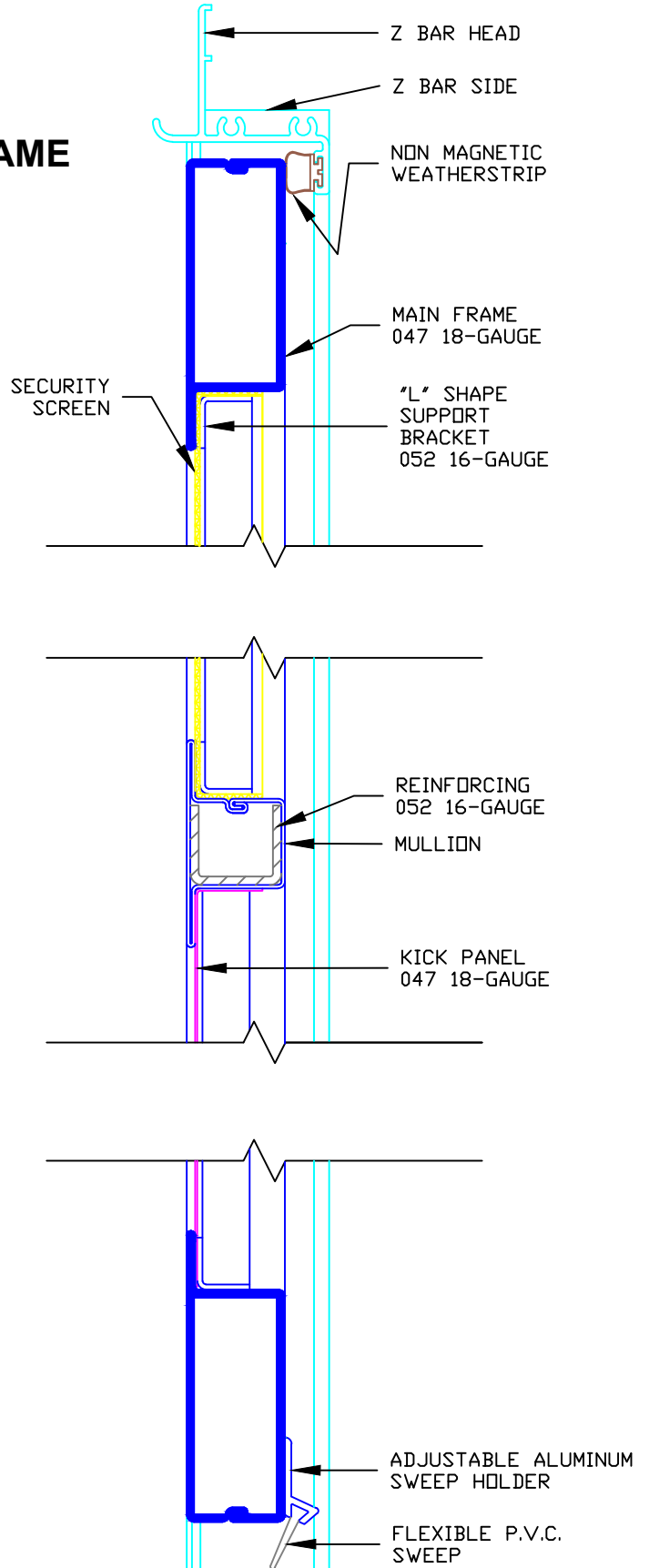

STEEL SECURITY SCREEN DOOR

MODEL # 3700, #3800, #3900

18 Gauge .047

GENERAL

- 1.1 Rusco Heavy Duty Stainless Steel Security Screen Doors are tested by a recognized testing laboratory, and it conforms to SMA 6001-2002 (heavy class) "Proposed American National Standard Specifications for Metal Protection Screens".
- 1.2 Stainless steel security screen doors shall be furnished complete with compression type weather-stripping, sill sweep and be pre-hung in an aluminum Z-bar frame ready for installation.

MATERIALS

- 2.1 Master frame shall be of 18 gauge .047 G90 hot dipped galvanized steel roll formed tubular lock seam construction.
- 2.2 Kick panel shall be 16 gauge galvanized steel, embossed for rigidity or model #3800 raised and embossed as per drawing.
- 2.3 Z-bars shall be extruded .062 aluminum and utilize compression type flexible vinyl weather-stripping on head and both jambs (Z-bar header with drip cap).
- 2.4 Stainless steel screen cloth to be 304 h alloy .028 inch diameter wire, 12 x 12 mesh with a tensile strength of not less than 800 pounds per inch after weaving.
- 2.5 Fastenings to be cadmium or zinc plated hardened steel screws, and can be concealed from view where possible.
- 2.6 Adjustable sill sweep shall be of extruded aluminum with flexible vinyl sweep.
OPTION: Box sweep with SANTOPRENE RUBBER sweeps.

RUSCO® MANUFACTURING INC. Specifications

STEEL SECURITY SCREEN DOOR MODEL # 3700, #3800, #3900

18 Gauge .047

CONSTRUCTION

- 3.1 Main frame sections shall be not be less than 2¼" x 15/16" roll formed lock seam construction, internal corner reinforcing gussets of 14 gauge steel. Full-face weld on both faces-buffed.
OPTION: Full face well on both faces - ground smooth
- 3.2 Transom and mullions to be notched, suitably reinforced and fully welded jamb rails on both sides of the master frame.
- 3.3 All mullions reinforced with 18 gauge .052 galvanized steel for support for closer installation.
- 3.4 Kick panels to be held in place with continuous 16 gauge galvanized steel angles and hardened steel screws.
- 3.5 Wire mesh screening shall have a 90 degree bend on all four sides and be held in place with 16 gauge continuous steel retainer angle applied with Rusco tamper proof screws 4" on centre to discourage easy removal. Fastening screws shall penetrate the steel angle, wire cloth, and continuous 16 gauge steel frame and mullion.
- 3.6 Doors to be hung in a pre-punched aluminum Z-bar subframe, using four tamper proof 304 stainless steel hinges (leaf and pin) with oil lite bearings and shall be fastened to the door into the 3/16 lock seam. Frames to be installed into existing frame using cadmium or zinc plated hardware screws.
OPTION: 1 ½ pair (3), 7" surface-mounted hinges with brass bushings.
- 3.7 KT 186 heavy duty hardware kits with Robertson installation screws, hardware kits to contain adjustable door closer, wind chain with hold up spring, also latch with exterior handle and interior locking mechanism with anti-lockout features.

FINISH

- 4.1 All steel sections will be chemically treated to ensure proper paint adherence.
- 4.2 All exposed surfaces of the door, wire mesh, aluminum Z-bars and aluminum sweep shall be finished with polyester powder paint, electrostatically applied and baked for a total of 20 minutes at 350°F. Colors to be selected from manufacturer's standard color range.

STEEL SECURITY SCREEN DOOR
MODEL # 3700, #3800, #3900

18 Gauge .047

PACKAGING

- 5.1 Doors will be carefully packaged using cardboard edge liners.

INSTALLATION

- 6.1 Verify that door openings are satisfactory and ready to accept pre-hung screen door.
- 6.2 The installer shall securely fasten doors in place in a straight, plumb, and level condition without distortion of the door or door frame, and shall make all final adjustments for proper operation and satisfactory weathering contact and seal in accordance with manufacture's instructions.
- 6.3 Clean up of property as the work proceeds and upon completion, touch up any marred enameled surfaces, remove all protective materials and dispose of all rubbish and surplus materials resulting from foregoing work.

WARRANTY

The entire door shall be guaranteed for a period of one (1) year from the date of delivery to the site. The guarantee shall cover the entire door against defects in design, material and workmanship.

The following exceptions shall apply to said warranty:

1. Normal wear and tear
2. Uniform fading of color
3. Improper maintenance
4. Abuse and carelessness

RUSCO SCREEN DOOR AND STORM DOOR INSTALLATION INSTRUCTIONS

WOOD B/M

1. Measure height of jamb on brickmould (latch and hinge sides)
2. Cut Z-bar to length on jamb sides.
3. Set door in opening and start by fastening hinge side first. Fasten through installation holes in face of Z-bar and next set gap at header and fasten (GAP 1/8" approximately). Remove shipping clips from latch sides and fasten. Screws should be 1 ¼ #8 Pan Head Robertson.
4. Fasten Z-bar through the hinge port left open in the stainless steel hinge with a screw long enough to secure the hinge side of the Z-bar from the inside.
5. Install storm door handle with screws provided and screw bottom of outside handle.
6. Mount closure bracket in line with mullion above the bottom kick panel, and fasten with screws provided in the hardware kit. Join closure to bracket using pin and pull closure to extend ½" and lock in place with lock ring. Fasten closure to door.
7. Fasten wind chain to top of door. Open door to just under 90°, and lock closer so you fasten other end of wind chain to header of frame using screws provided. (Be sure to hold chain tight but do not compress spring). Next, fasten spring to chain at centre link, and screw the other end of chain to the header to hold the chain up (fasten towards hinge side).
8. Set sweep at bottom of door and fasten with #8 x 1/2 " Pan Head Robertson screws. (Sweep should be touching sill by approximately 1/8"). Sweep to be installed on the exterior of the door.

STEEL B/M

1. Measure the height of the jamb on brickmould (latch and hinge sides)
2. Cut Z-bar to length on jamb sides.
3. Set door in opening and start by fastening hinge side first. Fasten through installation holes in face of Z-bar and next set gap at header and fasten (GAP 1/8 approximately). Remove shipping clips from latch side and fasten. Screws should be 3/4" #8 self-drilling Pan Head Robertson.
4. Fasten Z-bar through the hinge port left open in the stainless steel hinge, with a screw long enough to secure the hinge side of the Z-bar from the inside.
5. Install storm door handle with screws provided and screw bottom of outside handle.
6. Mount closure bracket in line with mullion above the bottom kick panel, and fasten with screws provided in the hardware kit. Join closure to bracket using pin and pull closure to extend ½" and lock in place with lock ring. Fasten closure to door.
7. Fasten wind chain to top of door. Open door to just under 90° and lock closer so you can fasten the other end of wind chain to header of frame using screws provided. (Be sure to hold chain tight but do not compress spring). Next, fasten spring to chain at centre link, and screw the other end of chain to the header to hold the chain up (fasten towards hinge side).
8. Set sweep at bottom of door and fasten with #8 x 1/2" Pan Head Robertson screws. (Sweep should be touching sill by approximately 1/8"). Sweep to be installed on the exterior of the door.

RUSCO® MANUFACTURING INC.

Specifications

**CLEANING AND CARING FOR
YOUR NEW RUSCO STEEL SCREEN OR STORM DOOR**

STEP ONE

Wash door and steel frame with a mild non-abrasive soap and soft cloth.

STEP TWO

Rinse door and frame with water and dry with chamois, making sure there are no water spots.

STEP THREE

Apply a good car wax as directed by wax manufacturer. Use a wax that is recommended to be done no more than twice per year.